

FOR FRONT RIGHT

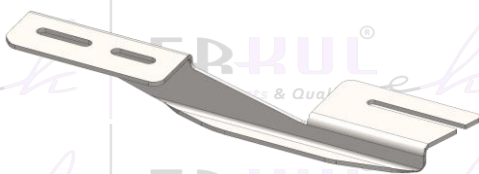

A (x2)

FOR REAR RIGHT

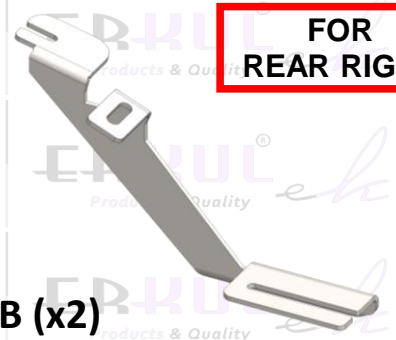

B (x2)

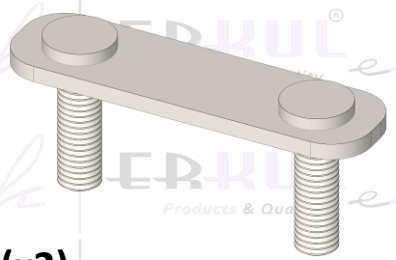

C (x2)

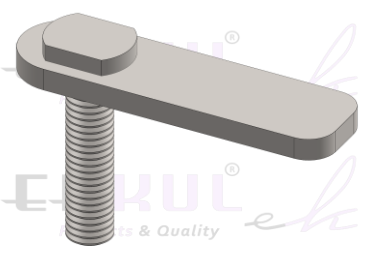

D (x2) M8



E (x2) M8

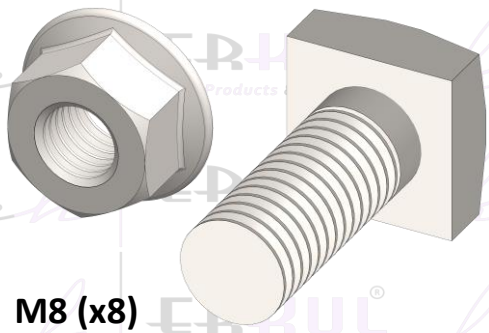

M8 (x8)

**M10 (x4)
M8 (x4)**

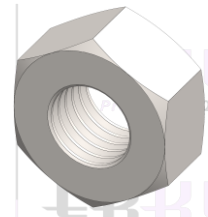

**M10 (x4)
M8 (x4)**

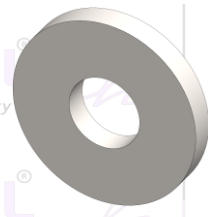

ERKUL
Products & Quality

RANGE ROVER EVOQUE 2012 → RUNNING BOARDS



FQC
FIRST QUALITY CERTIFICATION
ISO 9001:2008

DAkkS
Deutsche
Akkreditierungsstelle
D-ZM-19276-01-00

instructions

detaylar için

for details

detaylar için

FRONT BRACKET

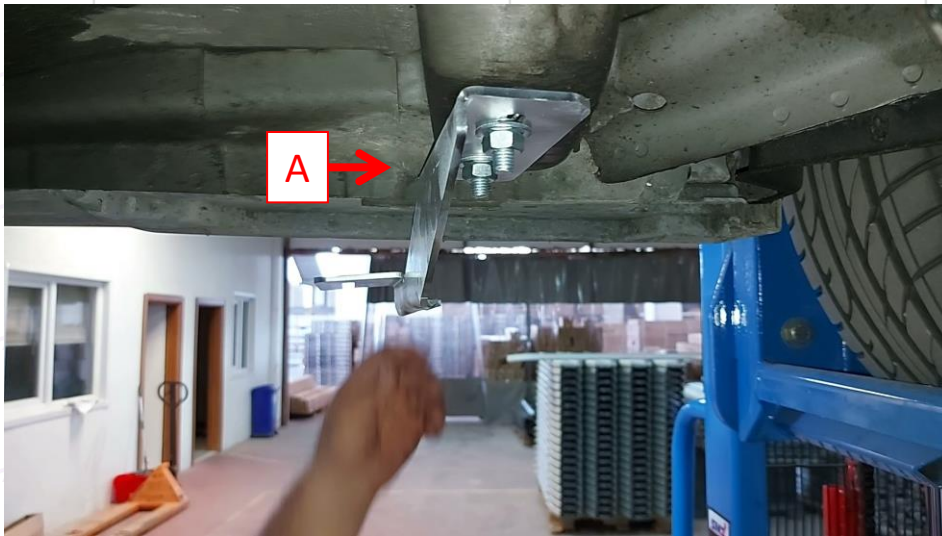
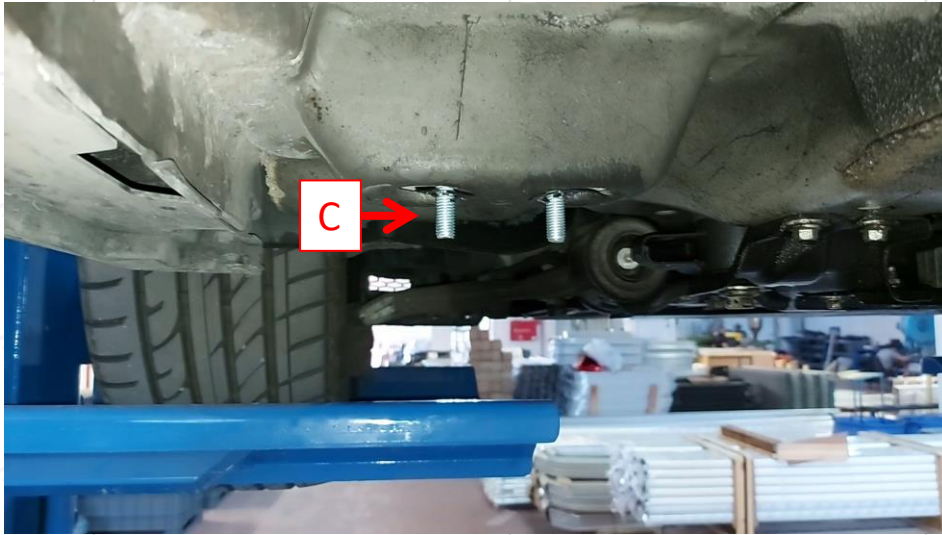

REAR BRACKET

