

**FOR
FRONT LEFT**

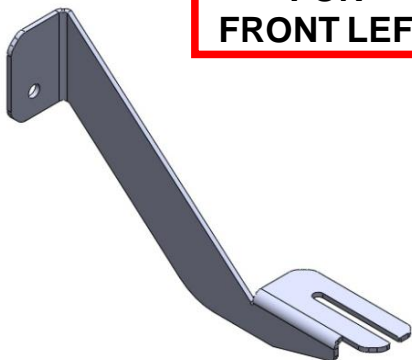

A (x2)

**FOR
MIDDLE LEFT**

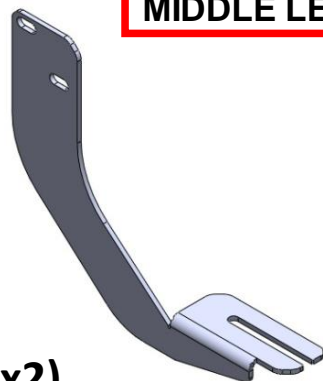

B (x2)

**FOR
REAR LEFT**

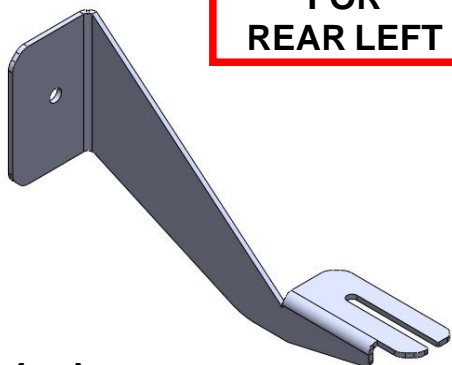

C (x2)

D (x4)

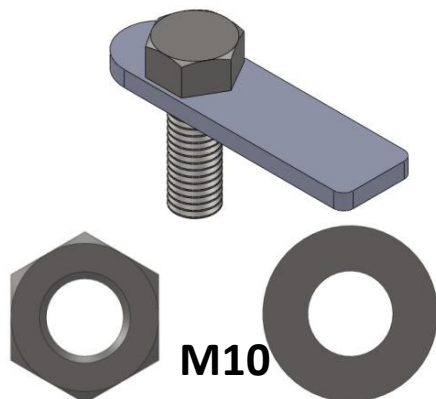

M10

E (M8x4)

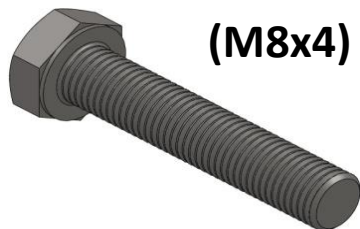

(M8x4)

(M8x8)

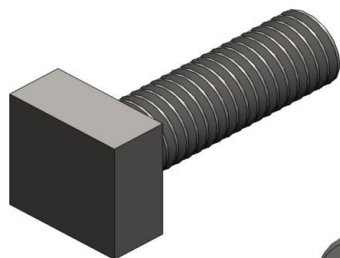

M8 (x12)



**GRATE WALL HOVER 2011 →
H3 – H5
RUNNING BOARD**



instructions



FRONT BRACKET

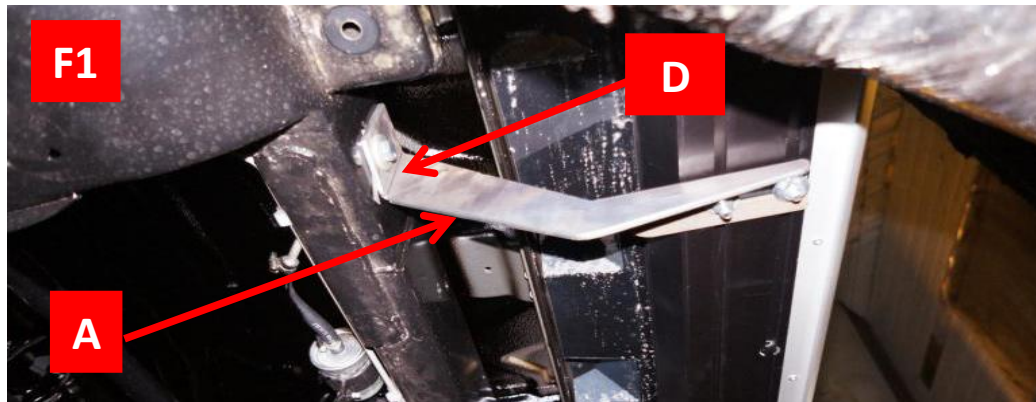

REAR BRACKET



MIDDLE BRACKET

