

FOR  
FRONT LEFT

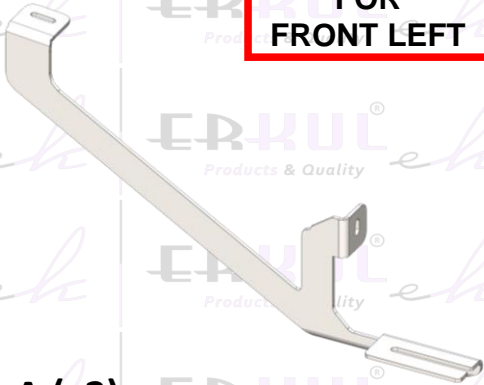

A (x2)

FOR  
MIDDLE LEFT

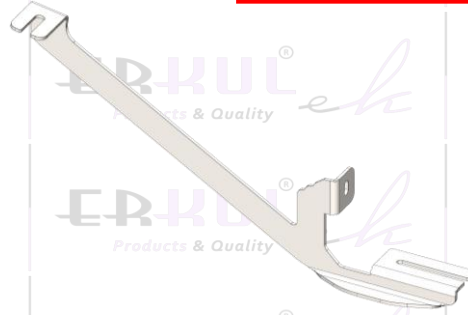

B (x2)

FOR  
REAR LEFT



C (x2)

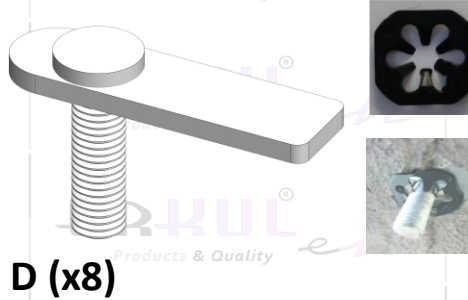

D (x8)

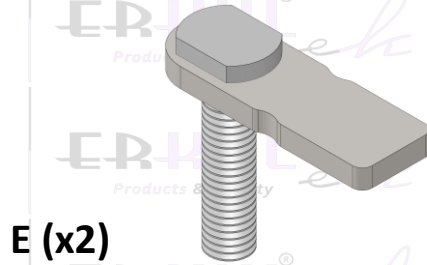

E (x2)

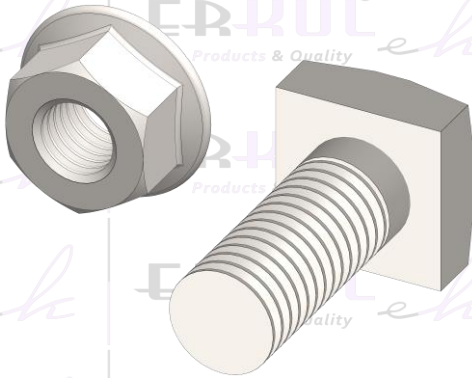

M8 (x12)

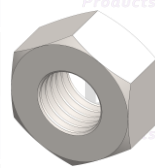

M8 (x10)

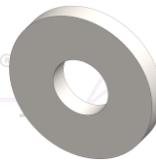

M8 (x10)



FORD TRANSIT 2014 →  
RUNNING BOARDS

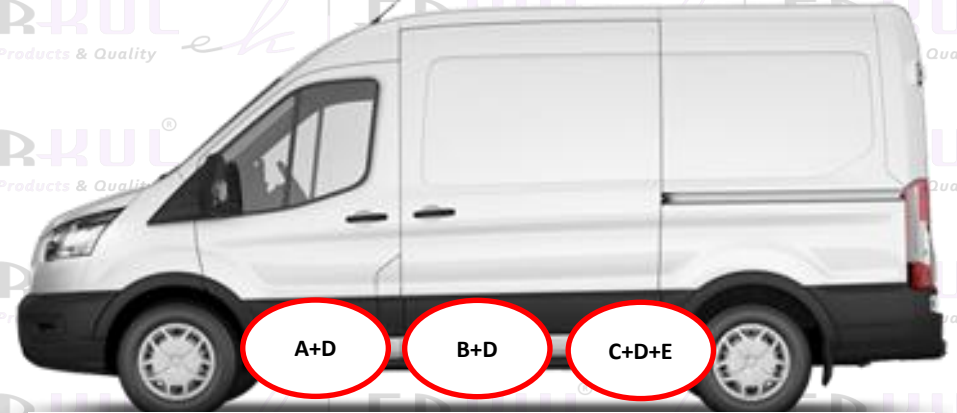

instructions



# FRONT BRACKET

D →



D →

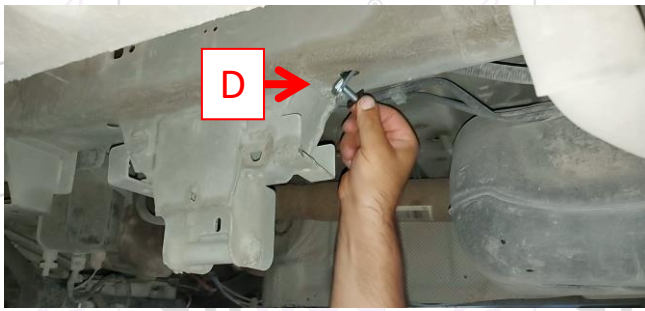

# MIDDLE BRACKET

← D



# REAR BRACKET

← D

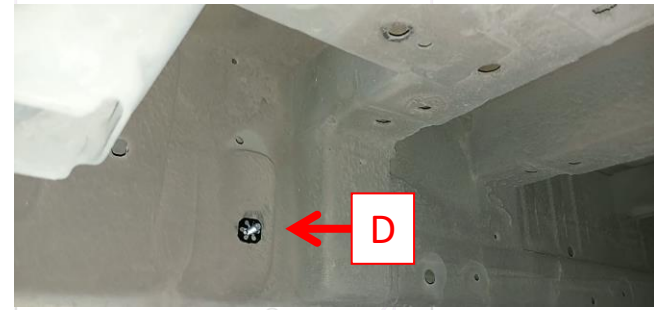

← E



A ↓



↑ B ↓



← C

